

“T-Type” insulating enclosures



Alongside the wide range of traditional metallic enclosures for ILME multipole connectors, there is now available a **new series of enclosures in self-extinguishing thermoplastic material** in the most common sizes of “44.27”, “57.27”, “77.27” and “104.27”.

Quality and low cost are the main features of these enclosures, as an outcome of careful product studies.

Valuable characteristics of these new enclosures:

- **significant structural solidity** and mechanical robustness by virtue of **substantial thickness**;
- **resistance to the main chemical agents**, found in industrial environments (see tab. page 281);
- **pre-fastened gaskets** for easier installation;



- **external dimensions** of the bulkhead mounting housings are **similar to those of the corresponding metallic enclosures**; hole fixing centres are **unchanged**.

“T-Type” insulating enclosures

- ample space inside enclosures for cables, with mounted connectors, similar to the corresponding metal high construction versions;
- possibility of making **completely insulated** constructions (equivalent to Class II);
- the **surface mounting** high construction housings are supplied **with an open threaded entry** and diametrically opposite a closed threaded entry, which can be **opened** by the user, if required (with suitable tool).



- **absence of powder paint** for environments in which these are not recommended;
- **non-electrostatic** thermoplastic material.
- manufactured from insulating material, do not require **special reinforced insulation** as the metal versions do, for use with series **CME higher voltage** connector inserts (screw-type terminals);
- protection rating for coupled connectors is **IP65** according to norm **IEC/EN 60529**;
- **UL Type 12** (= NEMA 12) degree of protection according to American standards **ANSI/UL 50** for indoor use;
- each enclosure carries its own part number and conformity markings;
- ambient temperature range: -40 °C / +90 °C

Featuring an original design, construction types available are:

- bulkhead mounting housings;



- surface mounting housings (with double entry of which one closed but threaded);



- single lever, side and top entry, for size (“44.27”);



- cover (for housings).



- hood with side entry;



- hood with top entry;



- single lever, side and top entry, for other sizes (“57.27, 77.27, 104.27”)



All used materials conform with the **RoHS 2002/95/EC Directive** and subsequent modifications.

New “T-Type” series insulating enclosures

1. Construction

Using the BC-MUL[®] moulding technique and use of MIL.BOX[®] material, these enclosures are structurally solid and mechanically robust, due to their increased thickness. They are particularly resistant to the main pollutants present in industrial environments. The lever enclosure pegs are built into the enclosures. The methods for fastening the connectors to the enclosures are made of M3 threaded metal inserts.

With reference to metal construction, which to comply with electrical installation safety norms, must be earthed via a metal connection to the grounding terminal of the inserts inside the enclosure, the new series of enclosures offers a solution for total insulation constructions (equivalent to class II) where necessary. The thermoplastic material used is RAL 7012 dark grey colour and **UL 94V-2** grade self-extinguishing and has passed glow wire testing in accordance with the IEC (EN) 60695-2-11 at **650 °C** in compliance with intended uses.

2. Gaskets

Gaskets have been produced by means of the FIPFG technology (Formed-In-Place-Foam-Gasket). They have therefore been incorporated in the base flange on bulkhead mounting housings for easier installation.

3. Levers

The locking levers have been produced in self-extinguishable thermoplastic material coloured grey RAL 7001.

4. Dimensions

The internal dimensions allow mounting of all connector inserts in their relevant sizes. The external dimensions of the bulkhead mounting housings are similar to those of the corresponding metallic enclosures; hole fixing centres are unchanged.

Hoods offer an inner cabling space similar to that of the “high” construction models of the corresponding metal enclosures. Other characteristics are in compliance with the applicable safety standard for electrical connectors, **IEC/EN 61984**.

5. Cable entries

The housing and hood cable entries are available with metric thread, respectively:

- **M25** or **M32** for smaller sizes “44.27” and “57.27”.
- **32** or **M40** for larger sizes “77.27” and “104.27”.

The surface mounting, high construction housings are supplied with an open threaded entry and diametrically opposite a closed threaded entry which can be opened by the user if required (with suitable tool).

The recent standard **IEC/EN 61076-7-100** regarding metric cable entries for multipole electrical connectors for heavy duty uses, which standardises some main dimensions for entries and their related accessories (gaskets, pressure nuts), have been carefully considered in the product design.

6. Markings

Each enclosure carries its own part number and conformity markings.

Interchangeability with other ILME series

TCH series housings can be coupled with metal hoods. Insulating hoods can be coupled with “V-Type” metal housings. Hoods “57.27”, “77.27” and “104.07” can be mounted on **COB TCQ** and **COB BC** frames simply by replacing the supplied levers with **COB L** levers (to be purchased separately).

Insulating enclosures are ideal for mounting of all ILME inserts with the exception of series models CT 40/ 64 and CTS 40/ 64 connector. Inserts with 45° terminals of the CTE series (screw-type terminals) and CTSE (spring terminals) are only insertable from the front (therefore not from the back) of the bulkhead mounting housings. Being made by insulating material, they do not require a special reinforced insulation as metal ones do, for use with series CME higher voltage connector inserts (screw-type terminals). With the exception of the limitations described below, it is generally possible to mount the MIXO series modular connectors and frames with the ground and screen anchors dedicated to this series.

Limitations

With respect to enclosures in metal alloy, ILME insulating enclosures have some limitations of use in combination with particular accessories:

- CRZ 06/ 10/ 16/ 24 reduction plates cannot be mounted with TCHI bulkhead mounting housings due to increased dimensions of the fastening flange of these insulating enclosures.
- The CYG 16 in-line joint cannot be mounted on the TCHI 16 bulkhead mounting housings because the gaskets of the latter do not fit together with the joint profile.
- The CYR 16.3 and CYR 24.4 round cable feed-throughs are difficult to position on their respective TCHI 16 and TCHI 24 bulkhead mounting housings.
- CPT 24 disposable protection cover cannot be mounted on insulating enclosures due to increased outer dimensions of these enclosures.
- MIXO series insert anchors cannot be mounted on TMAO 06/ 10 enclosures.
- MIXO series insert anchors cannot be mounted on TMAO 06/ 10 enclosures.
- When using both cable entries of surface mounting housings, the conduit shall be of insulating type.

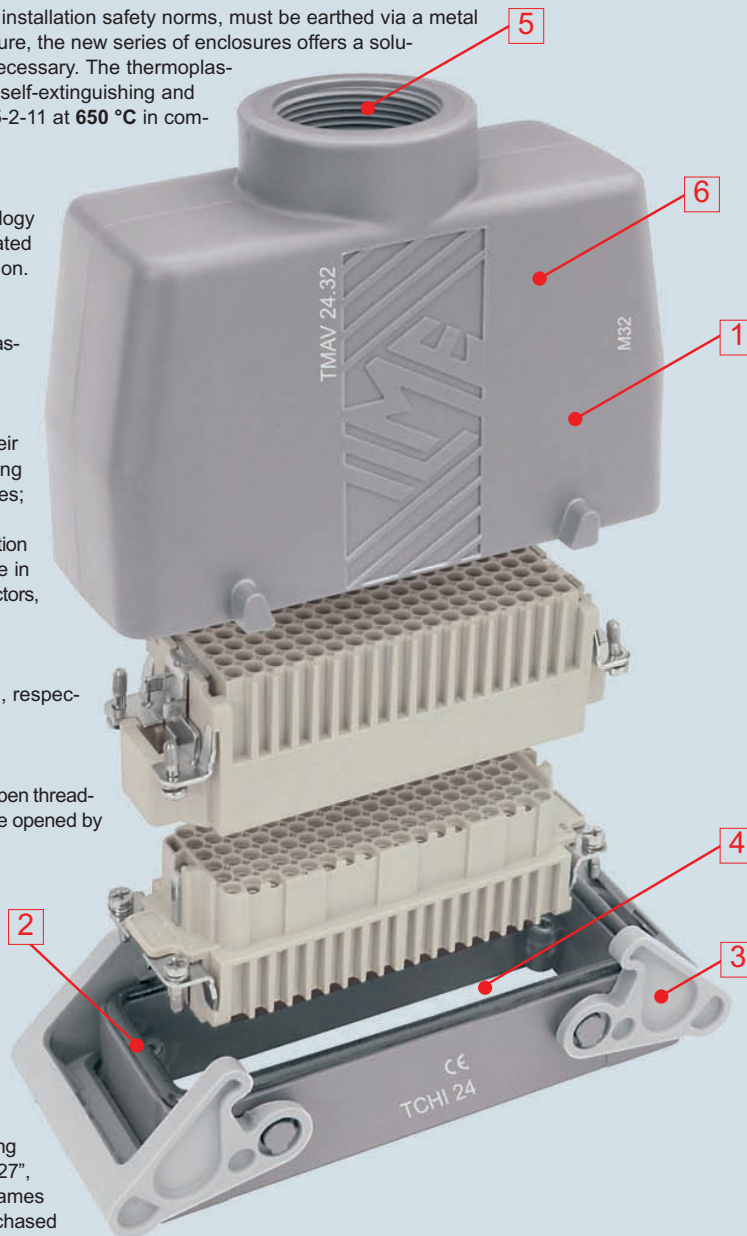

Ammonium acetate	●	Cyclohexane	○	Sodium nitrate	●
Wine vinegar	X	Potassium chlorate	●	Sodium nitrite	○
Acetone	X	Sodium chlorate	●	Fuel oils	○
Fatty Acids	●	Chlorine	X	Mineral oils (tasteless)	●
Boric acid	●	Ammonium chloride	●	Motor Oils	○
Boric acid, 10% aqueous solution	●	Chloride of lime diluted suspension	●	Mineral oil	●
Citric acid	X	Calcium chloride	●	Drilling oil	○
Hydrochloric acid <2% aqueous solution	X	Calcium chloride, 10% aqueous solution	●	Cutting oil	○
Lactic acid	●	Ferric chloride, 10% aqueous solution	X	Linseed oil	●
Concentrated hydrochloric acid	X	Potassium chloride	●	Paraffin oil	●
Oleic acid	●	Sodium chloride (salt)	●	Silicone oil	●
Oxalic acid	●	Cresol	○	IRM 901 oil , 20 ° C	●
Sulfuric acid, 2% aqueous solution	X	Decahydronaphthalene	X	IRM 902 oil , 20 ° C	○
Stearic acid	●	Potassium dichromate	○	IRM 903 oil , 20 ° C	○
Succinic acid	●	Diethylphthalate	●	Lubricating oil	●
Tartaric acid	●	Diisonophthalate	●	Transformer oil	●
Water	●	Sulphur dioxide	○	Vegetable oil	●
Boric water	●	Diotilphthalate	●	Octane (see also iso-octane)	○
Sea water	●	Heptane	○	Ozone	X
Aqua regia	X	Hexane	○	Sodium perborate	●
White alcohol (ethanol + isopropanol)	○	Turpentine	X	Potassium persulphate	○
Amyl alcohol	○	Ethanol	X	Petroleum	●
100% non-denatured ethyl alcohol	●	Light petroleum	○	Caustic potash (potassium hydroxide) 10%	X
Isopropyl alcohol	○	Diluted phenol	○	Propane	X
50% diluted methyl alcohol	○	Formalin	X	Common salt, aqueous solution	●
Alum	●	Ammonium phosphate	●	Tallow	●
Aqueous starch	●	Sodium phosphate	●	Sodium silicate	●
Gaseous ammonia	○	Diesel	○	Ammonium sulphate	●
Liquid ammonia	X	Gypsum (see calcium sulfate)	●	Calcium sulphate	●
Ammonia, 10% aqueous solution	●	Glycerine	●	Potassium sulphate	○
Aniline	○	Diluted glycerine	●	Copper sulphate, 10% aqueous solution	●
Moth killer	○	Ethylene or propylene glycol	●	Sodium sulphate	●
Asphalt	○	Diluted glycol	●	Sodium sulphide	●
Benzene	X	Diluted glucose	●	Cresolic solution	○
Petrol	○	Hydrogen sulphide	○	Solution for photo development	●
Petroleum ether	○	Sodium hydroxide (caustic soda)	X	Soap solution	○
Sodium bicarbonate (oxide)	●	12.5% sodium hydroxide (lye)	○	Fruit juices	●
Beer	●	Ink	●	Sodium thiosulphate (fixing salt)	●
Sodium bisulfite, aqueous solution	●	Potassium iodide	○	Toluene	X
Borax	○	Sodium hypochlorite (bleach)	X	Trichloroethylene	X
Gaseous butane	○	Mercury	●	Tricresyl phosphate	●
Liquid butane	○	Methanol	X	Diluted urea	●
Ammonium carbonate	●	Naphthalene	○	Urine	●
Potassium carbonate	●	N-Butanol	●	Xylene	X
Sodium carbonate (soda)	●	Ammonium nitrate	●	Sulphur	●
Tar	○	Calcium nitrate	●		
Potassium cyanide, aqueous solution	●	Potassium nitrate	○		

● = resistant

○ = limited resistance

X = not resistant

¹ The classification herewith provided is only a generic reference guide in order to enable a first selection. It is based on literature data provided by the suppliers of the raw materials used, which are related to tests made on specimens under test conditions which are not always homogeneous and involving accelerating techniques, therefore not necessarily describing real operational conditions. The actual behaviour of products in the field may therefore be positively or negatively influenced by several variable environmental parameters like temperature, relative humidity, presence at the same time of a plurality of substances and their concentration, exposure time, dynamic or static application condition, and so on. The accuracy of transferring the indications given herein to the actual conditions of use is therefore merely indicative and does not imply any guarantee or responsibility by ILME.



inserts:		page
CDD	24 poles + ⊕	59
CQE	10 poles + ⊕	80
CSH	6 poles + ⊕	88
CCE	6 poles + ⊕	94
CNE, CSE, JCNE, JCSE	6 poles + ⊕	95 and 106
CSS	6 poles + ⊕	118
CT, CTE, CTSE *	6 poles + ⊕	126 and 130
MIXO	2 modules	156÷195

insert centre distance:
44 x 27 mm

housings with single lever

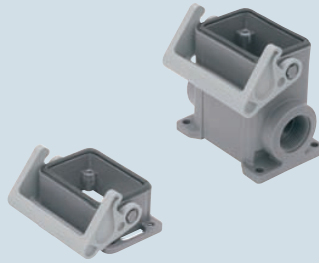

hoods with 2 pegs



description	part no.	entry M	part no.	entry M
bulkhead mounting housing with thermoplastic lever	TCHI 06 L			
surface mounting housing with thermoplastic lever	TMAP 06 L25	25		
surface mounting housing with thermoplastic lever	TMAP 06 L32	32		
hood with pegs, side entry			TMAO 06 L25	25
hood with pegs, side entry			TMAO 06 L32	32
hood with pegs, top entry			TMAV 06 L25	25
hood with pegs, top entry			TMAV 06 L32	32
cover with pegs	TCHC 06 L			

panel cut-out for bulkhead mounting housing in mm

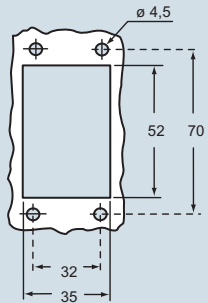

dimensions in mm

TCHI 06 L

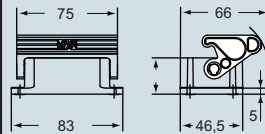

TMAP 06 L25 and TMAP 06 L32

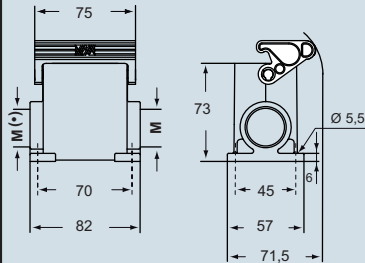

*) only for standard insulating version TCHI

(*) The surface mounting, high construction housings are supplied with an open threaded entry (•) and diametrically opposite a closed threaded entry which can be opened by the user if required (with suitable tool).

dimensions in mm

TMAO 06 L25 and TMAO 06 L32

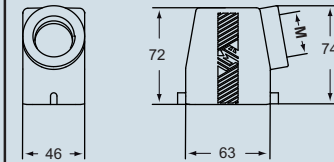

TMAV 06 L25 and TMAV 06 L32

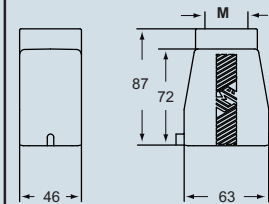

TCHC 06 L

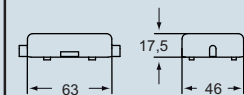

CAUS Type 12



- ambient temperature limits -40 °C / +90 °C.

dimensions shown are not binding and may be changed without notice



inserts:		page
CDD	42 poles + ⊕	61
CQE	18 poles + ⊕	81
CSH	10 poles + ⊕	89
CCE	10 poles + ⊕	96
CNE, CSE, JCNE, JCSE	10 poles + ⊕	97 and 107
CSS	10 poles + ⊕	119
CT, CTE, CTSE *)	10 poles + ⊕	127 and 131
CMSE	3+2 (aux) poles + ⊕	135
CMCE	3+2 (aux) poles + ⊕	134
CME	3+2 (aux) poles + ⊕	135
CX	8/24 poles + ⊕	151
MIXO	3 modules	156+195

insert centre distance:
57 x 27 mm

housings with double lever



hoods with 4 pegs



description	part no.		entry	
			M	
bulkhead mounting housing with thermoplastic lever	TCHI 10			
surface mounting housing with thermoplastic lever	TMAP 10.25		25	
surface mounting housing with thermoplastic lever	TMAP 10.32		32	
hood with pegs, side entry			TMAO 10.25	25
hood with pegs, side entry			TMAO 10.32	32
hood with pegs, top entry			TMAV 10.25	25
hood with pegs, top entry			TMAV 10.32	32
cover with pegs			TCHC 10	

panel cut-out for bulkhead mounting housing in mm

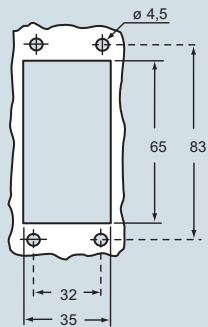

dimensions in mm

TCHI 10

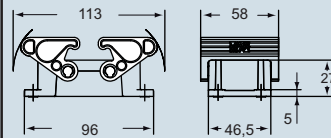

TMAP 10.25 and TMAP 10.32

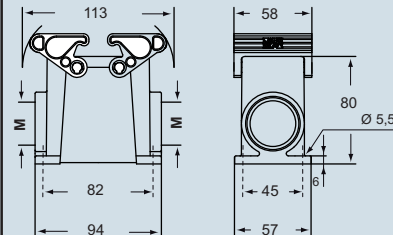

The surface mounting, high construction housings are supplied with an open threaded entry and diametrically opposite a closed threaded entry which can be opened by the user if required (with suitable tool).

dimensions in mm

TMAO 10.25 and TMAO 10.32

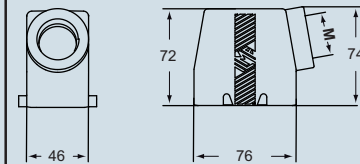

TMAV 10.25 and TMAV 10.32

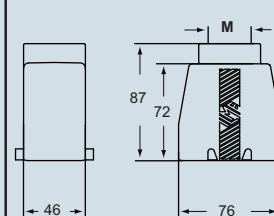

TCHC 10

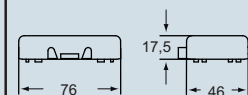

*) only for enclosure TCHI



- ambient temperature limits -40 °C / +90 °C.

dimensions shown are not binding
and may be changed without notice

T-TYPE - size 57.27