

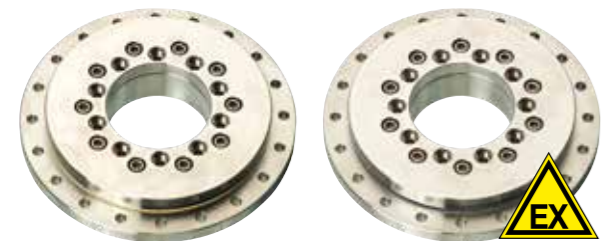

Standard

High temperature
up to +180°C



Stainless steel version

ESD-compliant

- Aluminium or stainless steel body (upon request)
- Replaceable maintenance-free sliding elements made of iglidur® J (Standard) ► **Page 159**, iglidur® H1 (for temperatures up to +180°C) ► **Page 333**, iglidur® F2 (ESD-compliant) ► **Page 493** or iglidur® A180 (FDA-compliant) ► **Page 401**

i Accessories
► From page 652

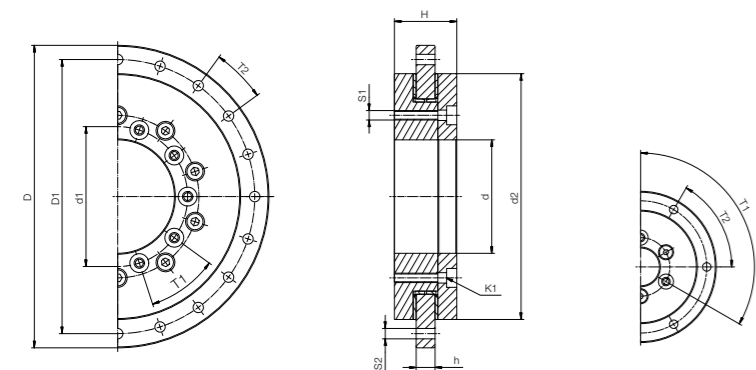

Dimensions [mm]

D ¹⁰⁾	D1	d1	d	d2	H	h	T1	T2	S1	S2	K1	R1	R2	B	Part No.	
				±0.2												
												for screw				
80	70	31	20	60	24	8	3 x 120°	6 x 60°	M4	4.5	DIN 7984 M4	M4	30	20	3.5	PRT-01-20-...
100	91	42.5	30	82	29	10	4 x 90°	8 x 45°	M4	4.5	DIN 7984 M4	M4	41	29	4.5	PRT-01-30-...
150	135	65	50	120	33	10	8 x 45°	16 x 22.5°	M6	6.6	ISO 4762 M6	M6	60	46.5	4.5	PRT-01-50-...
160	145	74	60	130	33	10	10 x 36°	20 x 18°	M5	5.5	ISO 4762 M5	M5	65	51.5	4.5	PRT-01-60-...
185	170	112	100	160	34	12	12 x 30°	16 x 22.5°	M5	5.5	ISO 4762 M5	M5	80	69	5.5	PRT-01-100-...
250	235	165	150	220	35	12	12 x 30°	16 x 22.5°	M5	5.5	ISO 4762 M5	M5	110	96.5	5.5	PRT-01-150-...
300	285	215	200	274	38	15	12 x 30°	16 x 22.5°	M6	6.6	ISO 4762 M6	M6	137	124	7.0	PRT-01-200-...
450	430	320	300	410	42	15	12 x 30°	16 x 22.5°	M8	9.0	DIN 7984 M8	M8	205	186.6	7.0	PRT-01-300-...

¹⁰⁾ Tolerance according to DIN ISO 2768 mK

All stainless steel versions upon request

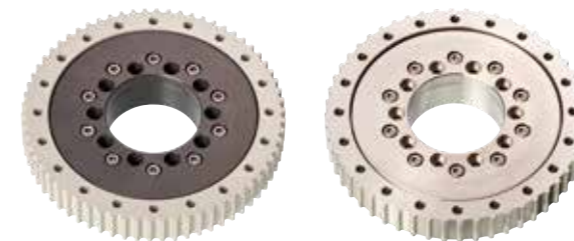

Standard

Stainless steel version

- 4 standards for outer rings are available
 - A classic spur gear according to DIN3967
 - Commercially available belt profiles: T10, AT10, HTD8M
- The inner ring is fixed and the outer ring driven
- The outer ring carries the item to be moved
- Outer ring available in stainless steel as an option (suffix "-ES")

Dimensions [mm]

D1	d1	d	d2	h	T1	T2	S1	S2	K1	R1	R2	B	H	Part No.
														for screw
70	31.0	20	60	18	6x60°	6x60°	M4	4.5	DIN 7984 M4	M4	30	20.0	3.5 (26.0)	PRT-01-20-TO-...
91	42.5	30	82	21	8x45°	8x45°	M4	4.5	DIN 7984 M4	M4	41	29.0	4.5 (30.5)	PRT-01-30-TO-...
135	65.0	50	120	10	8x45°	16x22.5°	M6	6.6	ISO 4762 M6	M6	60	46.5	4.5 (33.0)	PRT-01-50-TO-...
145	74.0	60	130	23	10x36°	20x18°	M5	5.5	ISO 4762 M5	M5	65	51.5	4.5 (34.5)	PRT-01-60-TO-...
170	112.0	100	160	25	12x30°	16x22.5°	M5	5.5	ISO 4762 M5	M5	80	69.0	5.5 (36.0)	PRT-01-100-TO-...
235	165.0	150	220	25	12x30°	16x22.5°	M5	5.5	ISO 4762 M5	M5	110	96.5	5.5 (36.5)	PRT-01-150-TO-...
285	215.0	200	274	30	12x30°	16x22.5°	M6	7.0	ISO 4762 M6	M6	137	124.0	7.0 (41.5)	PRT-01-200-TO-...
430	320.0	300	410	30	12x30°	16x22.5°	M8	9.0	DIN 7984 M8	M8	205	186.5	8.5 (43.5)	PRT-01-300-TO-...

**Spur gearing
DIN3967**

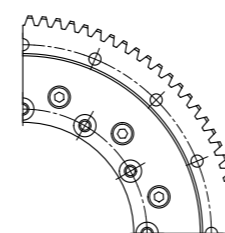

D	m	z	Part No. add-on
(88)	–	42	...-ST
(112)	2	54	...-ST
(160)	2	78	...-ST
(184)	2	90	...-ST
(196)	2	96	...-ST
(256)	2	126	...-ST
(308)	2	152	...-ST
(462)	3	152	...-ST

**Toothed belt profile
AT10**

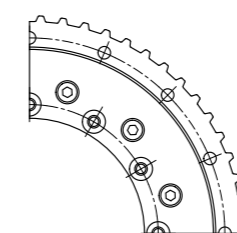

D	z	Part No. add-on
(87.25)	28	...-AT10
(106.4)	34	...-AT10
(157.3)	50	...-AT10
(163.8)	52	...-AT10
(189.2)	60	...-AT10
(252.9)	80	...-AT10
(303.9)	96	...-AT10
(456.7)	144	...-AT10

**Toothed belt profile
T10**

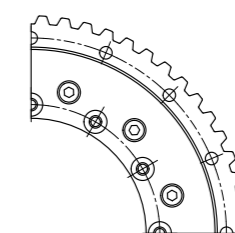

D	z	Part No. add-on
(87.25)	28	...-T10
(106.4)	34	...-T10
(157.3)	50	...-T10
(163.8)	52	...-T10
(189.2)	60	...-T10
(252.9)	80	...-T10
(303.9)	96	...-T10
(456.7)	144	...-T10

**Toothed belt profile
HTD5M (-20)/HTD8M**

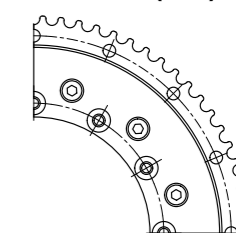

D	z	Part No. add-on
(81.25)	52	...-HTD5M
(110.7)	44	...-HTD8M
(161.6)	64	...-HTD8M
(166.7)	66	...-HTD8M
(187.1)	74	...-HTD8M
(253.3)	100	...-HTD8M
(304.3)	120	...-HTD8M
(457.1)	180	...-HTD8M

Order key

Type	Size [mm]	Options
PRT-01-	30	-TO-...-ES
Slewing ring	Design	Inner Ø
		Outer drive ring
		Tooth profile type
		Stainless steel version

